



D4728P

### Traffic Light Series 6091

- Explosion protection
  - CENELEC
  - IEC
- Can be used in Zone 1 and Zone 2
- Available with 1, 2 or 3 lenses
  - Lenses in:
    - Yellow
    - Clear
    - Red
    - Blue
    - Green
- 4 m long connection lead



Series 6091 traffic lights are for use in potentially explosive areas. The light sources used are 60 W incandescent bulbs with the symbol  to DIN 49 810.

#### Selection table

Version	Description	Ordering code	Weight [kg]
<b>Traffic light 6091</b>	with 1 lens	<b>6091/111-</b> □	6,0
	with 2 lenses	<b>6091/121-</b> □□	9,0
	with 3 lenses	<b>6091/131-</b> □□□	12,8

#### Add. to ordering code:





Specify lens colour

Lenze position: 6091/131-□□□



- |        |   |
|--------|---|
| yellow | 1 |
| clear  | 2 |
| red    | 3 |
| blue   | 4 |
| green  | 5 |

# Zone 1 and Zone 2





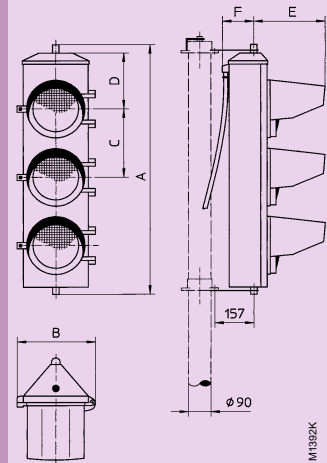

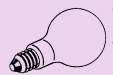

<b>Technical data</b>	
Explosion protection	EEx ed IICT*  Incandescent lamp * Temperature class  220 V, 235 V to 60 W T3  235 V to 60 W T2 24 V, 42 V to 60 W T2
Test certificate	ISSeP 92 C.102.918 X Other certificates: BKI (H), FTZU (CZ), SEV (CH)
Material Enclosure Gasket Reflector Lenses	Aluminium; colour: black stove enamel Neoprene Aluminium, anodized Coloured glass; visible Ø 204,5 mm; Colours: green, red, yellow, clear, blue
Special fixing	Stainless steel, screw/nut M 6
Lamps	Incandescent lamps E 27; 25 W, 40 W, 60 W with approval mark  or  to DIN 49 810 part 4 and 5
Rated voltage	24 V, 42 V, 230 V
Degree of protection	IP 54
Ambient temperature	- 20° C ... + 40° C
Connection	Cable H07RN-F, length: 4m 3 x 1,5 mm <sup>2</sup> for 1 lens 4 x 1,5 mm <sup>2</sup> for 2 lenses 5 x 1,5 mm <sup>2</sup> for 3 lenses

Dimensions, all dimensions in mm – subject to alteration

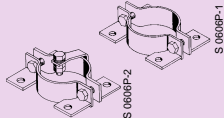

Dimensions [mm]

Version	A	B	C	D	E	F
1 lens	466	312	-	226	290	122
2 lenses	736	312	275	226	290	122
3 lenses	1006	312	275	226	290	122

<b>Selection table</b>					
Designation	Description	Ordering code	Weight [kg]		
Incandescent lamp		220 V  40 W	<b>512 622 0</b>	0,032	
		60 W	<b>512 623 0</b>	0,032	
		24 V 40 W	<b>461 090 0</b>	0,032	
		60 W	<b>461 091 0</b>	0,032	
		42 V 40 W	<b>461 092 0</b>	0,032	
60 W	<b>461 093 0</b>	0,032			
Mounting flange		For pole-mounting 1 pair	<b>60 910 01 49 0</b>	1,715	
Lens		Glass and frame complete			
		Colour: yellow	<b>60 910 02 58 0</b>	1,200	
		clear	<b>60 910 04 58 0</b>	1,200	
		red	<b>60 910 05 58 0</b>	1,200	
		blue	<b>60 910 01 58 0</b>	1,200	
green	<b>60 910 03 58 0</b>	1,200			
Sun cover		Aluminium, painted	<b>60 910 07 58 0</b>	0,375	
Wire guard		Steel wire, painted	<b>60 910 01 14 0</b>	0,125	
Reflector		Aluminium	<b>60 910 06 58 0</b>	0,100	
Lampholder		E27	<b>60 910 01 65 0</b>	0,330	

STAHL