

PROTECTA III

Pole Mounting Bracket

Cat No. SPRO4-0003



Pole mounting bracket to suit pole diameter 38mm - 50mm
Cat No. SPRO4-0003
Other sizes available on request.

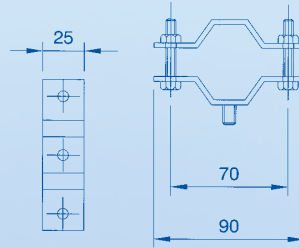

Hook Type Ceiling Bracket

Cat No. SPRO4-0005

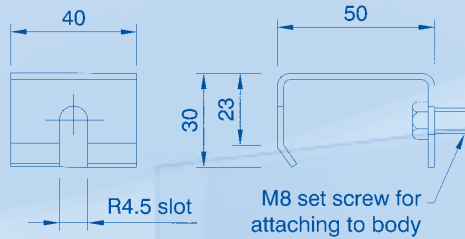

Ceiling Mounting Bracket

Cat No. SPRO4-0002

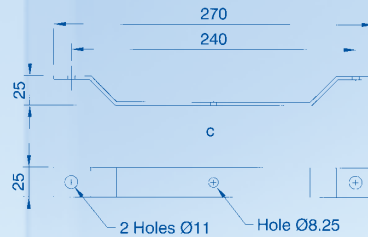

Eyelet Mounting Bracket

Cat No. SPRO5-0005

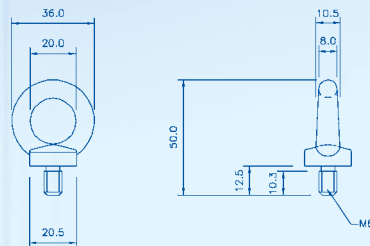

Flush Mounting Wall Bracket

Cat No. SPRO4-0006

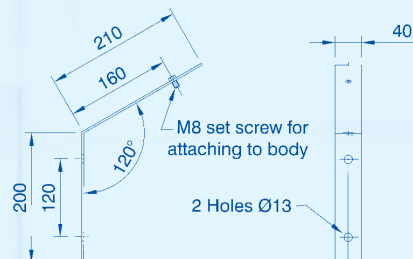

Note: All brackets are made from 316 Stainless Steel

MOUNTING OPTIONS

Wall Mounting Outreach Bracket

Cat No. NPRO4-0007/0008/0012

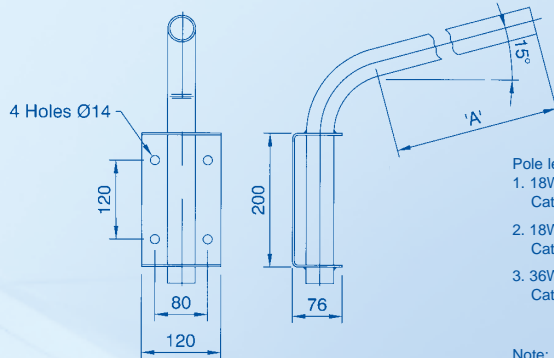

Pole length 'A' for use with the following:

1. 18W spigot entry body, size 'A' = 250mm
Cat No. NPRO4-0007
2. 18W body c/w pole clamps (SPRO4-0003), size 'A' = 650mm
Cat No. NPRO4-0008
3. 36W body c/w pole clamps, (SPRO4-0003) size 'A' = 1100mm
Cat No. NPRO4-0012

Note: Pole clamps for items 2, 3, & 4 must be ordered separately, see product accessories.

NPRO7-0007
18W & 36W Spigot Entry



18W Spigot Entry

Cat No. PRGE/218/BI/SE

Opening for pole mounting
and for cable entry - 36-44mm

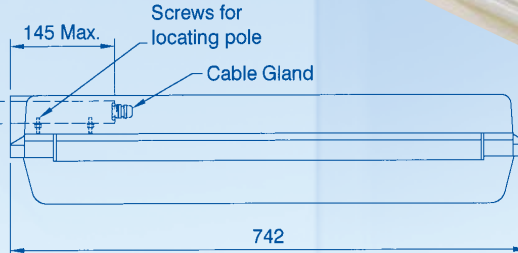
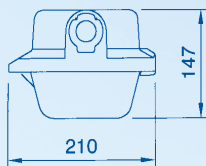

36W Spigot Entry

Cat No. PRGE/236/BI/SE

